

HD44780 16x02 Blaues Display mit Serielle Schnittstelle Datenblatt



Content:

- [1. Basic Specifications](#)
- [2. Absolute Maximum Ratings for LCD Display](#)
- [3. Electrical Characteristics of LCD Display](#)
- [4. Pinout](#)
- [5. Connection Diagrams](#)
- [6. Precautions](#)

1. Basic Specifications

- Module dimensions: 80 mm x 36 mm x 12.5 mm
- View area: 12 mm x 56 mm
- Resolution: 16 Characters x 2 Lines
- Backlight: ED, White
- View Angle: 180 degrees
- Modes: Parallel (8bit and 4bit)
- Operating Voltage: 3.3V and 5V
- Operating temperature: from -10°C to +60°C
- Storage temperature: from -30°C to +80°C
- I2C Adapter Default I2C Address: 0x27; Address selectable - Range 0x20 to 0x27

2. Absolute Maximum Ratings for LCD Display

Item	Symbol	Min.	Typ.	Max.	Unit
Supply Voltage for Logic	VDD-VSS	-0.3	-	+7	V
Power Supply for LCD	VLCD	VDD-15	-	VDD+0.3	V
Input Voltage	VIN	-0.3	-	VDD+0.3	V
Supply Current for Backlight	ILED	-	-	25	mA

3. Electrical Characteristics of LCD Display

Item	Symbol	Condition	Min.	Typ.	Max.	Unit
Power Supply for LCM	VDD-VSS	-	4.8	5.0	5.2	V
			3.0	3.3	3.6	V
Input Voltage	VIL	L Level	-0.2	-	1	V
	VIH	H Level	VDD-1.0	-	VDD	V
LCD Driving Voltage	VDD-VO	-	4.5	4.8	5.1	V
Supply Current for LCM	IDD	VDD = 5V	-	-	1500	μA
		VDD = 3.3V	-	-	1250	
Supply Current for Backlight	ILED	-	-	15	-	mA

4. Pinout

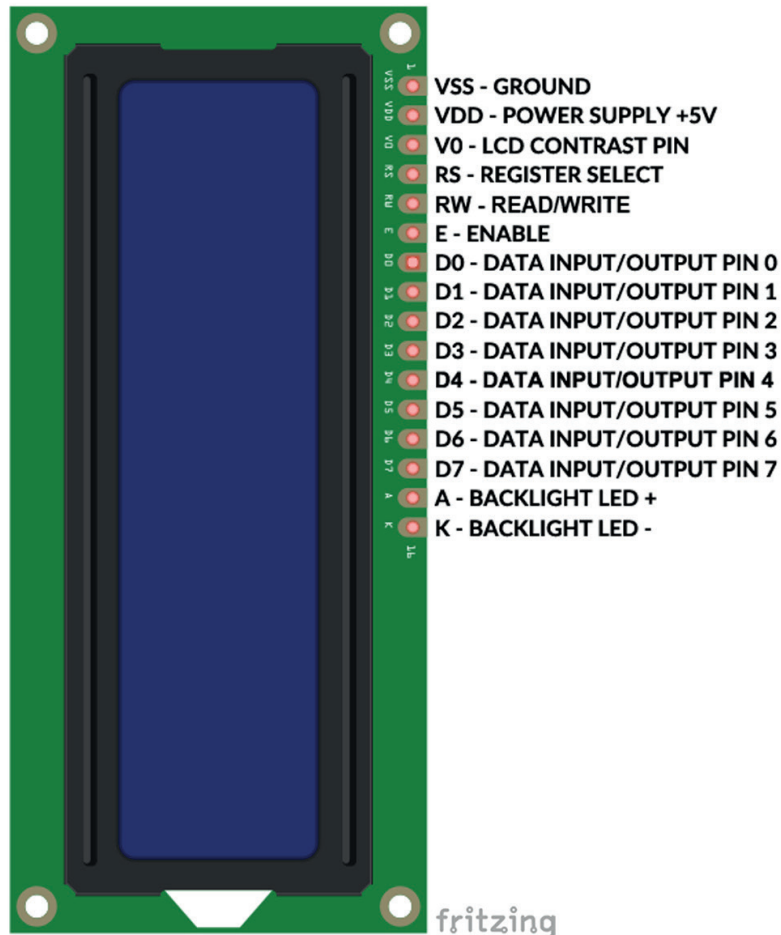

The VO pin uses analog voltage to set up the screen contrast level. Hardware contrast adjustment can be done by using voltage divider or potentiometer.

The anode pin A and cathode pin K are positive and negative terminals that are used to control the backlight of the screen.

The RW pin, or Read/Write pin, is used to set the data direction, to read data from display-driver chip or to write data into the screen driver chip.

The RS pin is Register Select pin which is used to shift between command or data registers of the driver chip.

The E pin, or Enable pin, is used to enable/disable communication between the main micro-controller and the driver chip of the screen.

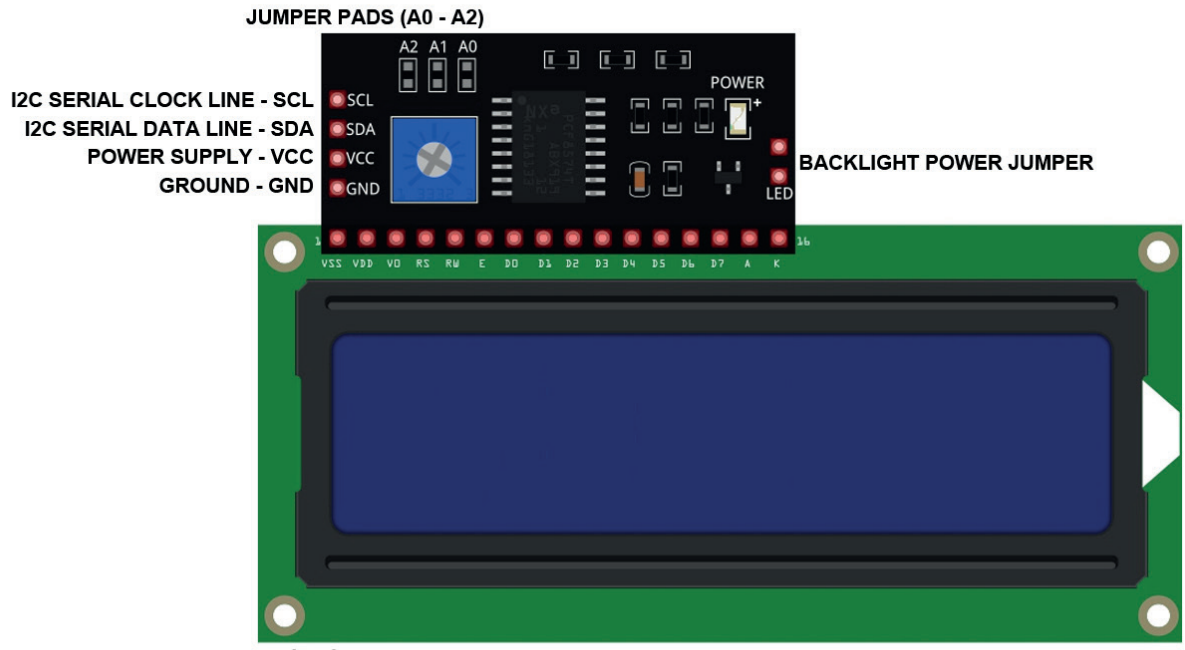

5. Connection Diagrams

Connect the HD44780 16x02 LCD Display with the Uno as shown on the following connection diagram:

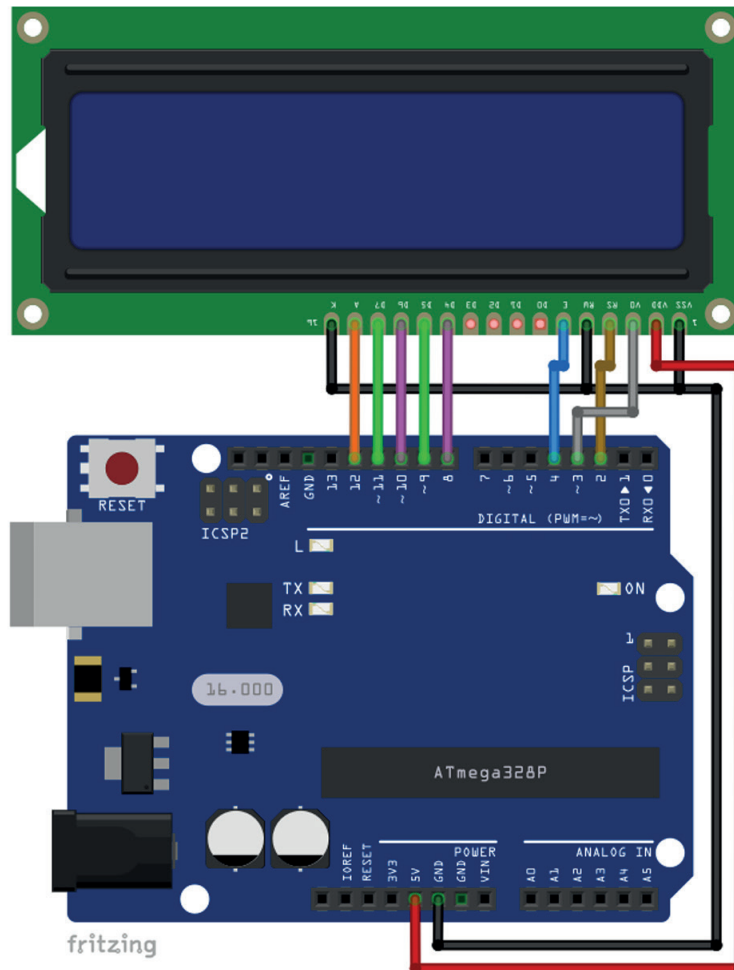

Screen pin	Uno pin	Wire color
VSS	GND	Black wire
VDD	5V	Red wire
V0	D3	Gray wire
RS	D2	Ochre wire
RW	GND	Black wire
E	D4	Blue wire
D4	D8	Purple wire
D5	D9	Green wire
D6	D10	Purple wire
D7	D11	Green wire
K	GND	Black wire
A	D12	Orange wire

Connect the HD44780 16x02 LCD Display with the I2C Serial Adapter as shown on the following connection diagram:

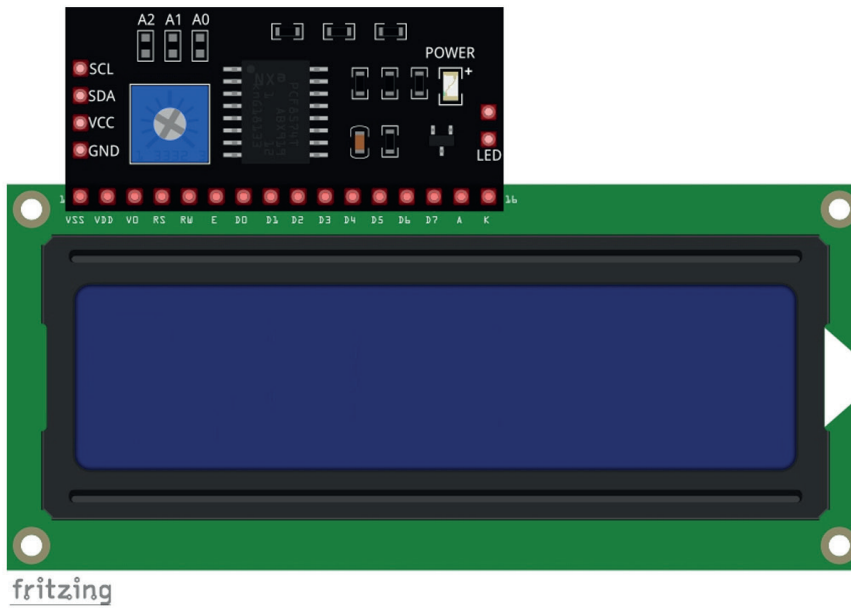

Connect the HD44780 16x02 LCD Display I2C Bundle with the Uno as shown on the following connection diagram:

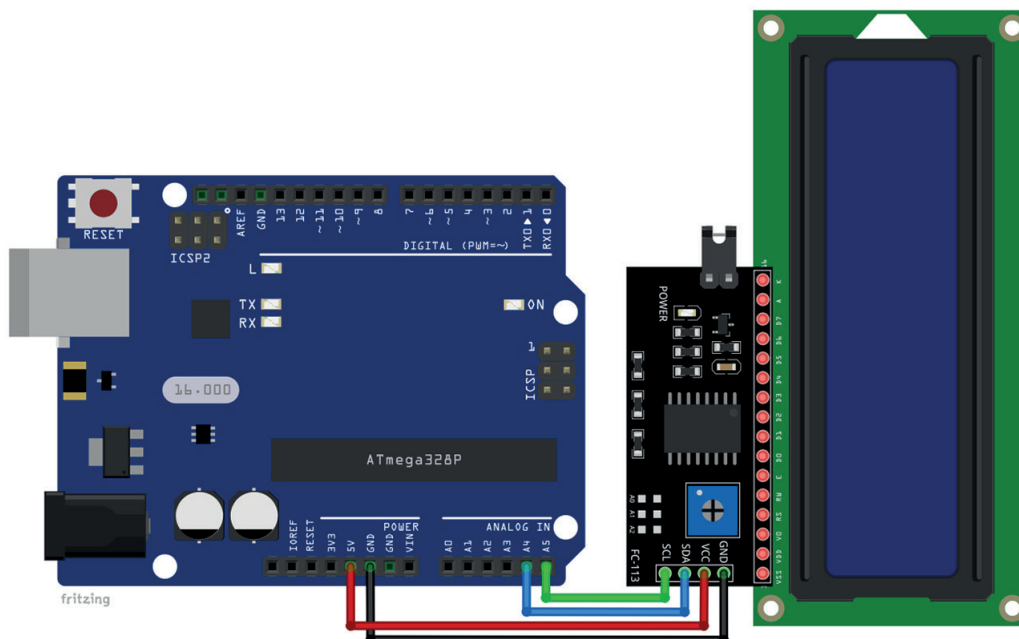

Connect the HD44780 16x02 LCD Display with the Raspberry Pi as shown on the following connection diagram:

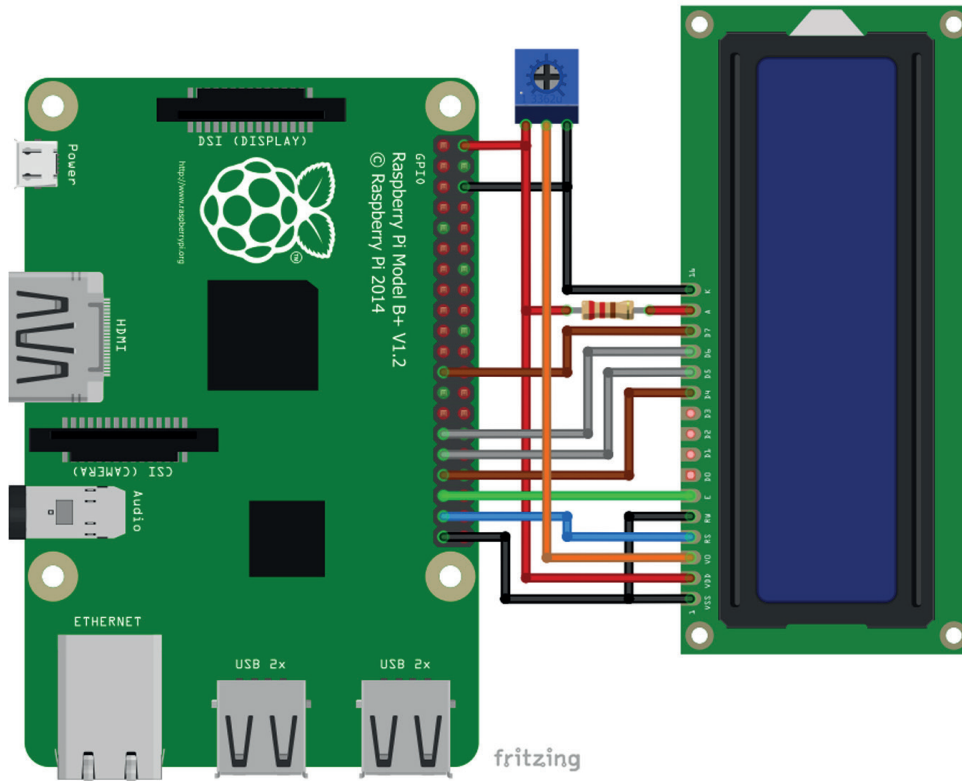

Screen pin	Raspberry Pi pin	Physical pin	Wire color
VSS	GND	6	Black wire
VDD	5V	2	Red wire
RS	GPIO26	37	Blue wire
RW	GND	39	Black wire
E	GPIO19	35	Green wire
D4	GPIO13	33	Brown wire
D5	GPIO6	31	Gray wire
D6	GPIO5	29	Gray wire
D7	GPIO11	23	Brown wire
K	GND	6	Red wire
A	5V, via 220Ω resistor	2	Orange wire
V0	potentiometer center pin		

Potentiometer			
GND	Right pin	6	Black wire
5V	Left pin	2	Red wire

Connect the HD44780 16x02 LCD Display I2C Bundle with the Raspberry Pi as shown on the following connection diagram:

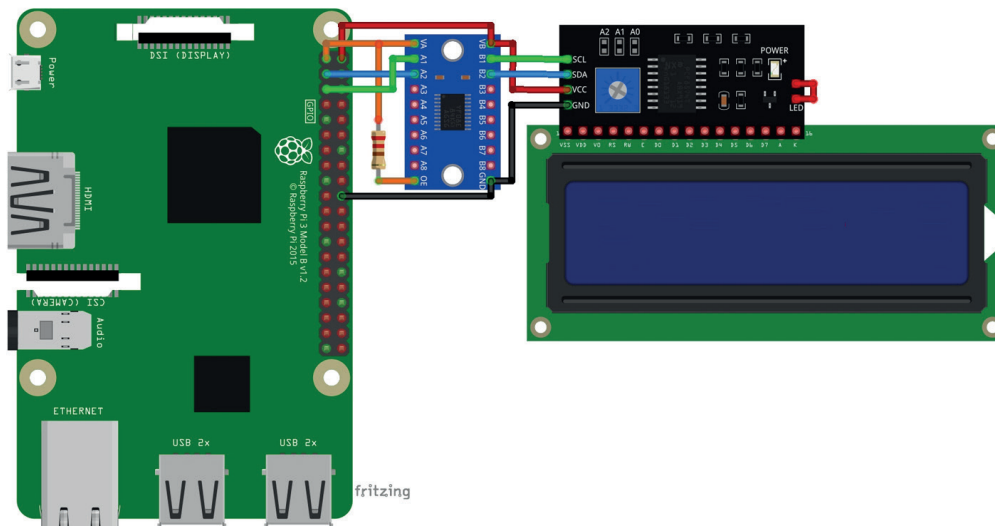

Please note that to use HD44780 20x04 LCD Display I2C bundle with Raspberry Pi, using Logic Level Converter is needed, which you can also pick up from our catalog.

6. Precautions

- This device is susceptible to Electro-Static Discharge (ESD) damage. Observe Anti-Static precautions.
 - Do not apply excessive force to display surface or the adjoining areas since this may cause the color tone to vary.
 - The polarizer covering display surface of the LCD module is soft and easily scratched. Handle this polarizer carefully.
 - If display surface becomes contaminated, breathe on the surface and gently wipe it with a soft dry cloth. If it is heavily contaminated, moisten cloth with Isopropyl or alcohol.
 - Solvents other than those above-mentioned may damage the polarizer. Especially, do not use the Water.
 - Exercise care to minimize corrosion of the electrode. Corrosion of the electrodes is accelerated by water droplets, moisture condensation or a current flow in a high-humidity environment.
 - Install LCD Module by using the mounting holes. When mounting the LCD module make sure it is free of twisting, warping and distortion. In particular, do not forcibly pull or bend the cable or the backlight cable.
 - Do not attempt to disassemble or process LCD module.
 - NC terminal should be open. Do not connect anything.
 - If the logic circuit power is off, do not apply the input signals.
 - To prevent destruction of the elements by static electricity, be careful to maintain an optimum work environment.
 - Be sure to ground the body when handling LCD modules.
 - Tools required for assembling, such as soldering irons, must be properly grounded.
- To reduce the amount of static electricity generated, do not conduct assembling and other work under dry conditions.
- The LCD module is coated with a film to protect the display surface. Exercise care when peeling off this protective film since static electricity may be generated.

- Identify and, at all times, observe absolute maximum ratings for both logic and LC drivers.
- Prevent the application of reverse polarity to VDD and VSS, however briefly.
- Use a clean power source free from transients. Power-up conditions are occasionally jolting and may exceed the maximum ratings of these LCD modules.
- The VDD power of LCD module should also supply the power to all devices that may access the display. Do not allow the data bus to be driven when the logic supply to the module is turned off.
- Operate this LCD module within the limits of the modules temperature specifications.
- Surface of the LCD panel should not be touched or scratched. The display front surface is an easily scratched, plastic polarizer.
- Always employ anti-static procedure while handling EastRising module.
- Do not store in direct sunlight.
- If leakage of the liquid crystal material should occur, avoid contact with this material, particularly ingestion. If the body or clothing becomes contaminated by the liquid crystal material, wash thoroughly with water and soap.
- When storing the LCD modules, avoid exposure to direct sunlight or to the light of fluorescent lamps.
- Keep LCD modules in bags (avoid high temperature / high humidity and low temperatures below 0°C.
- Liquid crystals solidify under low temperature (below the storage temperature range) leading to defective orientation or the generation of air bubbles (black or white). Air bubbles may also be generated if the module is subject to a low temperature.
- To minimize the performance degradation of the LCD modules resulting from destruction caused by static electricity etc., exercise care to avoid holding the following sections when handling the modules.
 - Exposed area of the printed circuit board.
 - Terminal electrode sections.
- Please keep the temperature within specified range for use and storage. Polarization degradation, bubble generation or polarizer peel-off may occur with high temperature and high humidity.
- Do not touch, push or rub the exposed polarizers with anything harder than an HB pencil lead (glass, tweezers, etc.).

AZ-Delivery

Ihr Experte für Mikroelektronik!

If you are looking for the high quality products for Arduino and Raspberry Pi, AZ-Delivery Vertriebs GmbH is the right company to get them from. You will be provided with numerous application examples, full installation guides, eBooks, libraries and assistance from our technical experts.